

APPLIED MODEL

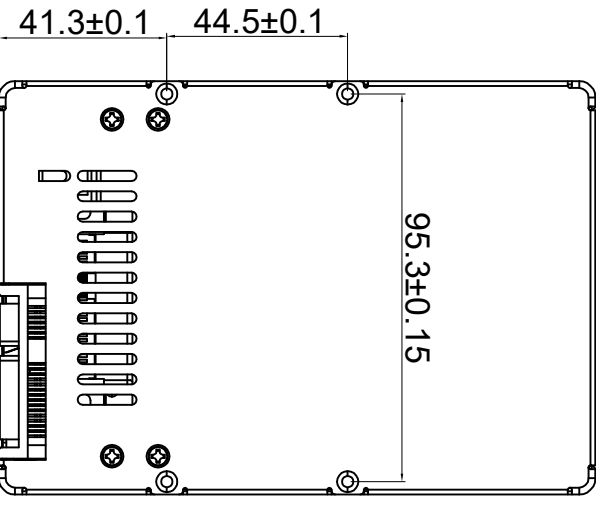
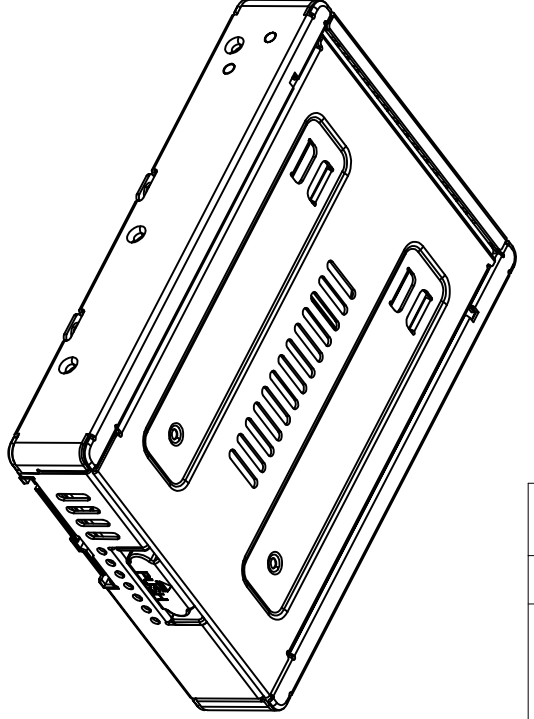
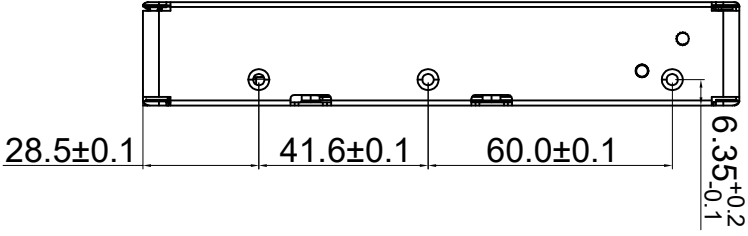
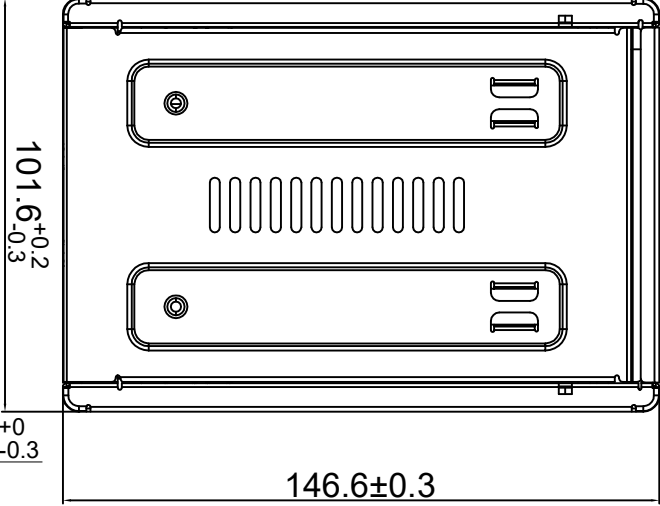
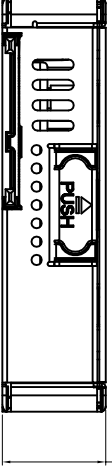
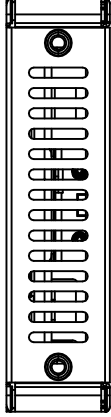
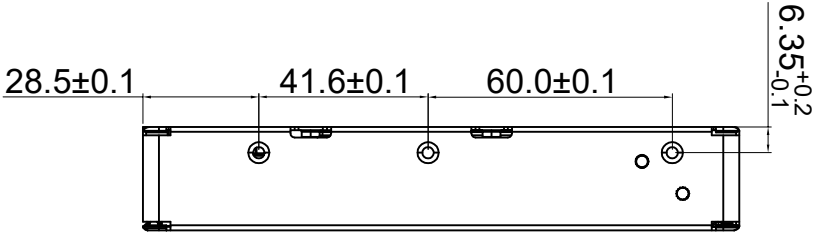

CREMAX TECH CO., LTD.

TITLE		MATERIAL		TOLERANCE	
MB982IP-1S-1 組立図		XX 4A3			
DRAWN	DATE	FINISHED	UNIT	SCALE	
CHECKED	DATE	PART NO.	MM	1:	
APPROVED	DATE	DWG. NO.	SHEET	OF	