

M.2 NVMe SSD Mobile Rack for External 3.5" Bay

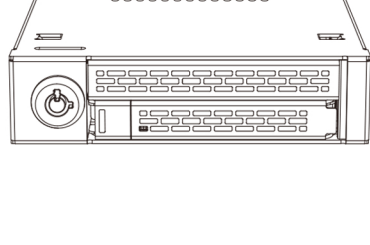

MB833M2K-B

MB833MK-B V2

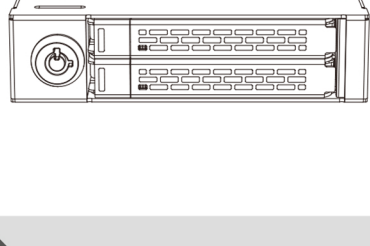
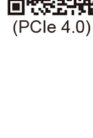
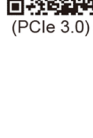

MB834M2K-B

MB834MK-B V2

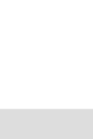
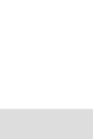

Copyright © ICY DOCK International. All Rights Reserved. 650293 VER 1.0

1

Package Contents • Packungsinhalt • Contenu • Contenido del paquete • 包装について • 包装説明 • 包装说明



(MB833M2K-B / MB833MK-B V2) (MB834M2K-B / MB834MK-B V2)

Device



(MB833M2K-B / MB833MK-B V2) (MB834M2K-B / MB834MK-B V2)

Thermal Pads

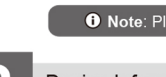

User Manual

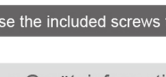

4 x M3*4 Screw for Device

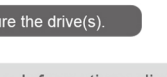

2 x Key

Note: Please use the included screws to secure the drive(s).

2

Device Information • Geräteinformationen • Informations dispositif • Information del dispositivo • 本体説明 • 機體説明 • 机体说明

Front View

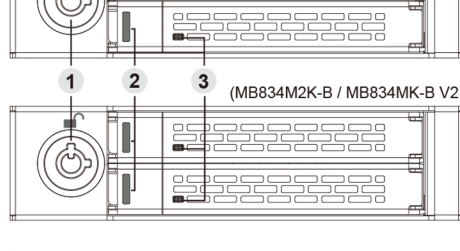

- 1 2-Segments Keylock
- 2 Drive Tray Unclatch Button
- 3 LED Indicator (Drive Power: Solid Green ; Drive Access: Flashing Green)

Rear View

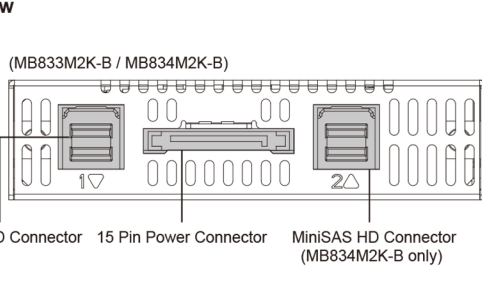

MiniSAS HD Connector 15 Pin Power Connector MiniSAS HD Connector (MB834M2K-B only)

15 Pin Power Connector 2 x OCuLink Connector (MB833MK-B V2 only has 1 x OCuLink Connector)

Tray Inner View

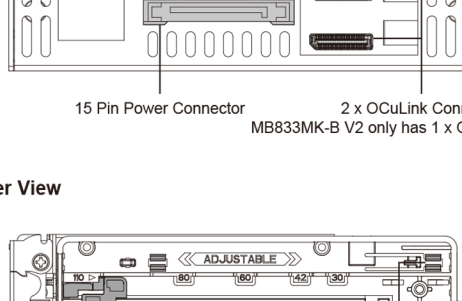

Adjustable M.2 SSD Locker M.2 SSD 22110/2280/2260/2242/2230 Lock Points Heat Sink Secure Points

3

Installation Guide • Installationsanleitung • Guide d'Installation • Guía de instalación • 製品の組み込み手順について • 操作步驟 • 操作步驟

3-1



Push to eject

3-2

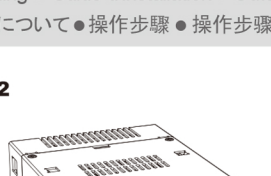

3-3

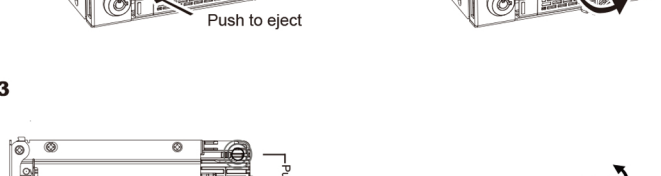

The metal heat sink needs to be removed before M.2 SSD installation. To remove, simply push the heat sink upward from the rear underside of the drive tray

3-4

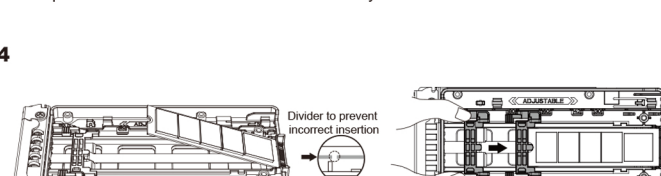

To prevent incorrect positioning of the M.2 SSD, align the gap between the connector of the M.2 SSD to the drive tray's slot divider. Then insert the M.2 SSD towards the connector slot

With the M.2 SSD laying flat on the tray, slide the adjustable locker to secure the M.2 SSD

3-5

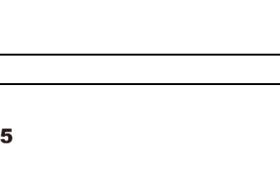

M.2 NVMe SSD (not included)

(Optional) Remove the clear protective films from the small piece of memory chip(s) and place them on lower flash memory chip(s) to fill the surface gap between the chips and the larger thermal pad for best conductive heat transfer. Skip this step if the memory chips are at the same heights

3-6

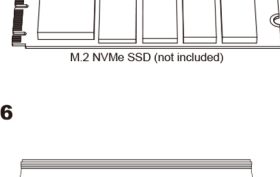

Thermal pad

Remove the protective films from the larger thermal pad and then place it onto the heat sink cover

3-7



Place the removed heat sink cover back on

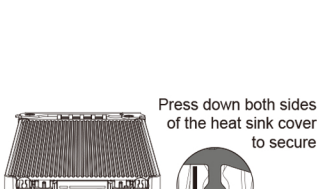

Press down both sides of the heat sink cover to secure

3-8

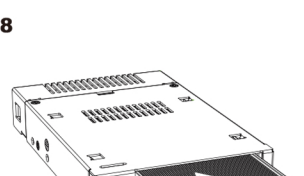

3-9

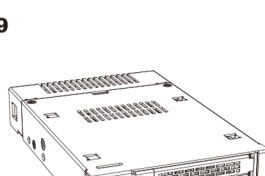

4-1 . Installing Device into 3.25" Bay - Insert the device into external 3.25" bay and use the included M3*4 screws to secure the device.

MB833M2K-B / MB834M2K-B

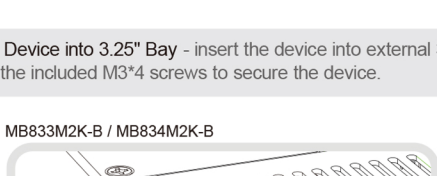

1. Use a small plier to remove the plastic cover on the MiniSAS HD ports before connecting the cables

MB833M2K-B / MB834M2K-B / MB833MK-B V2 / MB834MK-B V2

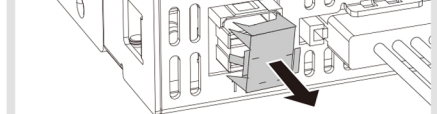

Please use the included M3x4 screws only

2. Insert the device into external 3.5" bay and use the included M3x4 screws to secure the device



For the warranty information, please visit www.icydock.com/warranty.php